

# TODO

**BLUEWATER RUBBER AND GASKET  
HOUMA**  
1131 Barrow St.  
Houma, LA 70360  
Phone: 985.851.2400  
Toll Free: 800.521.4673  
[www.BluewaterRubber.com](http://www.BluewaterRubber.com)

# BLUEWATER

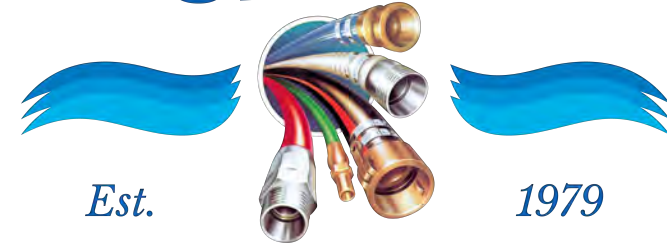

*Est.* 1979  
**RUBBER & GASKET CO.**

# TODO® PRODUCTS OVERVIEW

Setting the industry  
standard for over  
40 years

## THE NUMBER 1 CHOICE FOR SAFE LIQUID TRANSFER

TODO® is the market leader in the DRY-BREAK® industry, trusted by clients around the globe. Our products are designed to handle a huge range of oils, gases and hazardous chemicals. For over four decades TODO® valves have been used in the most challenging conditions.



# 01

## TODO-MATIC®

### REDUCED SPILLAGE, INCREASED PROFIT

TODO-MATIC® couplers are extremely reliable, with very few moving parts, and require little operator intervention which reduces the risk of human error. The TODO-MATIC® range's minimal residual loss of product on disconnection and spillage is virtually zero, assuring site safety. Less product leakage also means more product delivered to your customers, resulting in higher profit margins.

# TODO



**BLUEWATER RUBBER AND GASKET  
HOUMA**

1131 Barrow St.  
Houma, LA 70360  
Phone: 985.851.2400  
Toll Free: 800.521.4673  
[www.BluewaterRubber.com](http://www.BluewaterRubber.com)

**TODO****1" TODO-MATIC® DRY-BREAK®**DN20  
DN32  
Ø56 mm  
→HOW  
IT  
WORKS**BLUEWATER**

- Dedicated for small bore applications
- One-handed operation
- High flow rate
- Minimal release on disconnection
- Additional option of selectivity to prevent product cross-contamination

**BLUEWATER RUBBER AND GASKET  
HOUMA**1131 Barrow St.  
Houma, LA 70360  
Phone: 985.851.2400  
Toll Free: 800.521.4673  
[www.BluewaterRubber.com](http://www.BluewaterRubber.com)

**2" TODO-MATIC® DRY-BREAK®**DN32  
DN65  
Ø70 mm  
→HOW  
IT  
WORKS

- Suitable for various applications
- Available in a range of materials and configurations
- Provides rapid, safe transfer
- Additional option of selectivity to prevent product cross-contamination

**TODO****BLUEWATER***Est.**1979***RUBBER & GASKET CO.****BLUEWATER RUBBER AND GASKET  
HOUMA**1131 Barrow St.  
Houma, LA 70360  
Phone: 985.851.2400  
Toll Free: 800.521.4673  
[www.BluewaterRubber.com](http://www.BluewaterRubber.com)

## 2.5" TODO-MATIC® DRY-BREAK®

DN65  
DN80  
Ø105mm  
→HOW  
IT  
WORKS

- Ideal for road tanker and aviation applications
- Suitable for a variety of liquids and vapours
- Strong integral swivel
- Ergonomic design
- Rugged construction
- Additional option of selectivity to prevent product cross-contamination

**TODO****BLUEWATER****BLUEWATER RUBBER AND GASKET  
HOUMA**

1131 Barrow St.  
Houma, LA 70360  
Phone: 985.851.2400  
Toll Free: 800.521.4673  
[www.BluewaterRubber.com](http://www.BluewaterRubber.com)

**3" TODO-MATIC® DRY-BREAK®**DN80  
DN100  
Ø119mm  
→HOW  
IT  
WORKS

- Typically used for rail and road loading/discharge
- Tough construction
- Ergonomic design
- High flow rate
- Zero spillage
- The natural choice for NATO refuelling standardisation
- Additional option of selectivity to prevent product cross-contamination

**TODO****BLUEWATER***Est.**1979***RUBBER & GASKET CO.****BLUEWATER RUBBER AND GASKET  
HOUMA**1131 Barrow St.  
Houma, LA 70360  
Phone: 985.851.2400  
Toll Free: 800.521.4673  
[www.BluewaterRubber.com](http://www.BluewaterRubber.com)

**4" TODO-MATIC® DRY-BREAK®**DN100  
Ø164 mm  
→HOW  
IT  
WORKS

- Rapid connection and disconnection
- Applications include:
  - off-shore ship-to-rig transfer of fuels and drinking water
  - aviation fuel bunkering
  - rail tank loading/discharge
  - chemical transfer
- Additional option of selectivity to prevent product cross-contamination

**TODO****BLUEWATER***Est.**1979***RUBBER & GASKET CO.****BLUEWATER RUBBER AND GASKET  
HOUMA**

1131 Barrow St.  
Houma, LA 70360  
Phone: 985.851.2400  
Toll Free: 800.521.4673  
[www.BluewaterRubber.com](http://www.BluewaterRubber.com)

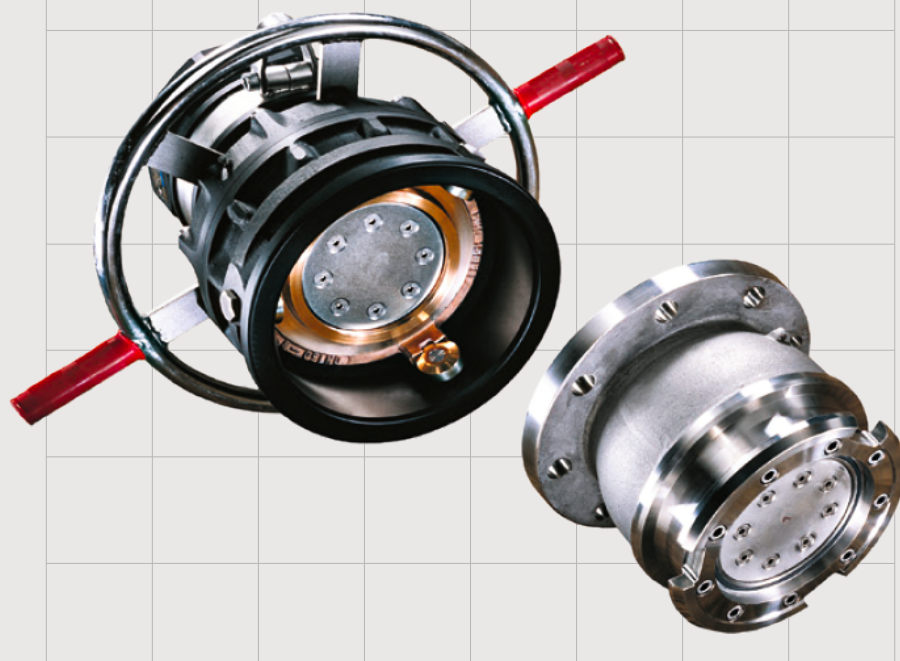
**6" TODO-MATIC® DRY-BREAK®**DN150  
Ø238mm  
→HOW  
IT  
WORKS

- Ideal for ship- or barge-to-shore connection
- Significantly faster transfer than any flange coupling
- Environmental standards compliant
- Provides real turnaround time savings
- Rotating lifting loop as standard
- Additional option of selectivity to prevent product cross-contamination

**TODO****BLUEWATER***Est.**1979***RUBBER & GASKET CO.****BLUEWATER RUBBER AND GASKET  
HOUMA**

1131 Barrow St.  
Houma, LA 70360  
Phone: 985.851.2400  
Toll Free: 800.521.4673  
[www.BluewaterRubber.com](http://www.BluewaterRubber.com)

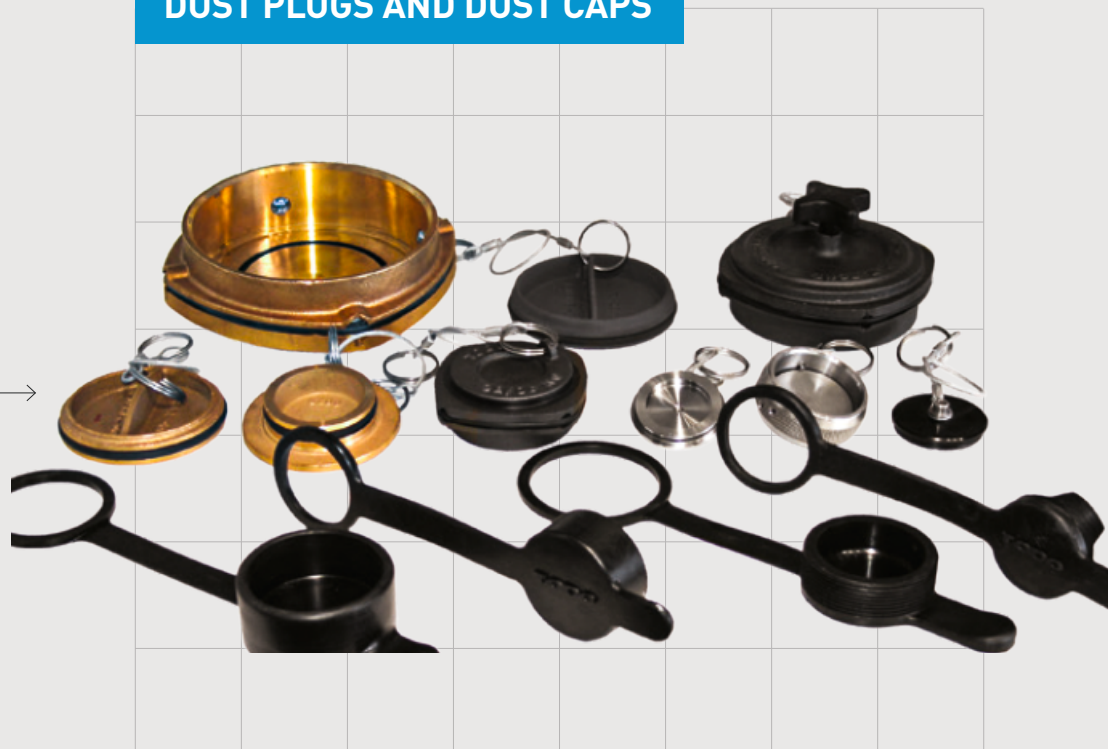

**DUST PLUGS AND DUST CAPS**Sizes:  
1"-6"

- Prevent ingress of dirt and water
- Available in:
  - Stainless steel
  - Brass/gunmetal
  - Aluminium
  - Rubber

**TODO****BLUEWATER**  
*Est.* 1979  
**RUBBER & GASKET CO.****BLUEWATER RUBBER AND GASKET  
HOUMA**  
1131 Barrow St.  
Houma, LA 70360  
Phone: 985.851.2400  
Toll Free: 800.521.4673  
[www.BluewaterRubber.com](http://www.BluewaterRubber.com)

# 02

## TODO-GAS

### SAFE TRANSFER OF LPG IN BOTH LIQUID AND VAPOUR PHASES

Improve profit margins, environmental credentials and operator safety when transporting liquid petroleum gas. Specifically designed for the safe transfer of LPG, TODO-GAS couplings are composed of materials ideal for the unique properties of LPG and terminal handling properties. TODO-GAS 1" and 2" products have dimensionally different connection geometry to restrict product cross-contamination. Their unrivalled technology also significantly reduces emissions and removes the risk of operator freeze burns.

# TODO



**BLUEWATER RUBBER AND GASKET  
HOUMA**

1131 Barrow St.  
Houma, LA 70360  
Phone: 985.851.2400  
Toll Free: 800.521.4673  
[www.BluewaterRubber.com](http://www.BluewaterRubber.com)

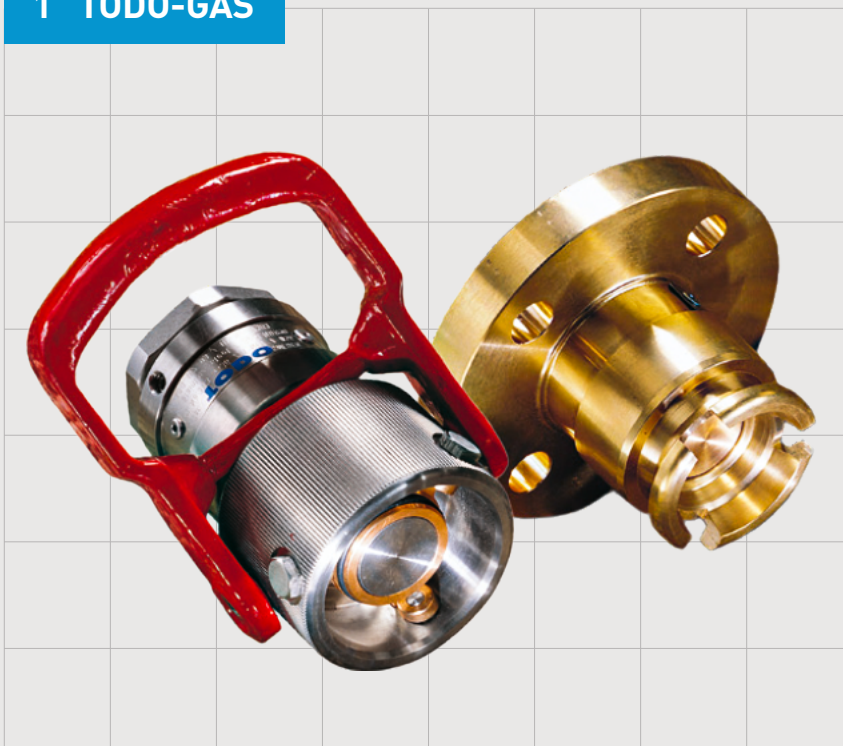
**TODO****1" TODO-GAS**DN19  
DN32  
Ø56 mm  
→HOW  
IT  
WORKS

- Suitable for a range of LPG applications
- Heavy duty autogas vehicle refuelling
- Advanced vapour recovery systems
- Easy to connect and disconnect
- Single-handed operation
- Ultra-low release on disconnect: 0.15cc per disconnection
- Suitable for indoor fuelling
- Handles up to 200 litres/minute (52 USG/MIN)
- Minimal pressure drop

**BLUEWATER RUBBER AND GASKET  
HOUMA**

1131 Barrow St.  
Houma, LA 70360  
Phone: 985.851.2400  
Toll Free: 800.521.4673  
[www.BluewaterRubber.com](http://www.BluewaterRubber.com)

## 2" TODO-GAS

DN40  
DN50  
Ø71 mm  
→HOW  
IT  
WORKS

- Ideal for bobtails or immediate bulk delivery trucks
- Rugged construction
- Suitable for frequent use
- Can cope with almost any loading equipment configuration
- Ultra low release on disconnect: 0.35cc per disconnection

**TODO****BLUEWATER***Est.**1979***RUBBER & GASKET CO.****BLUEWATER RUBBER AND GASKET  
HOUMA**

1131 Barrow St.  
Houma, LA 70360  
Phone: 985.851.2400  
Toll Free: 800.521.4673  
[www.BluewaterRubber.com](http://www.BluewaterRubber.com)

## 3" TODO-GAS

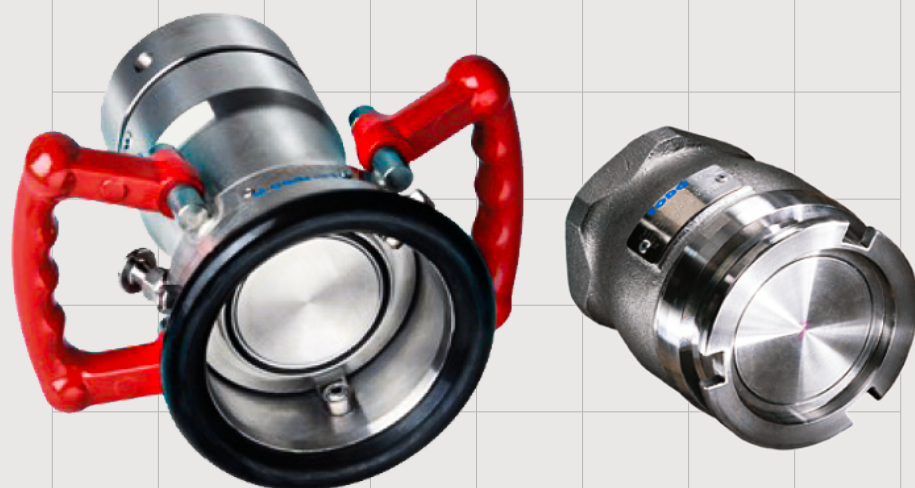
DN80  
Ø119 mm  
→HOW  
IT  
WORKS

- Unrivalled suitability for larger or high flow rate applications
- Typically used for rail tank loading and discharge
- Handles flows of up to 2,500 litres/minute (658 USG/MIN)
- Two-handle operation
- Robust integral swivel
- Designed to withstand regular use at terminal

**TODO****BLUEWATER***Est.*

1979

**RUBBER & GASKET CO.****BLUEWATER RUBBER AND GASKET  
HOUMA**

1131 Barrow St.  
Houma, LA 70360  
Phone: 985.851.2400  
Toll Free: 800.521.4673  
[www.BluewaterRubber.com](http://www.BluewaterRubber.com)

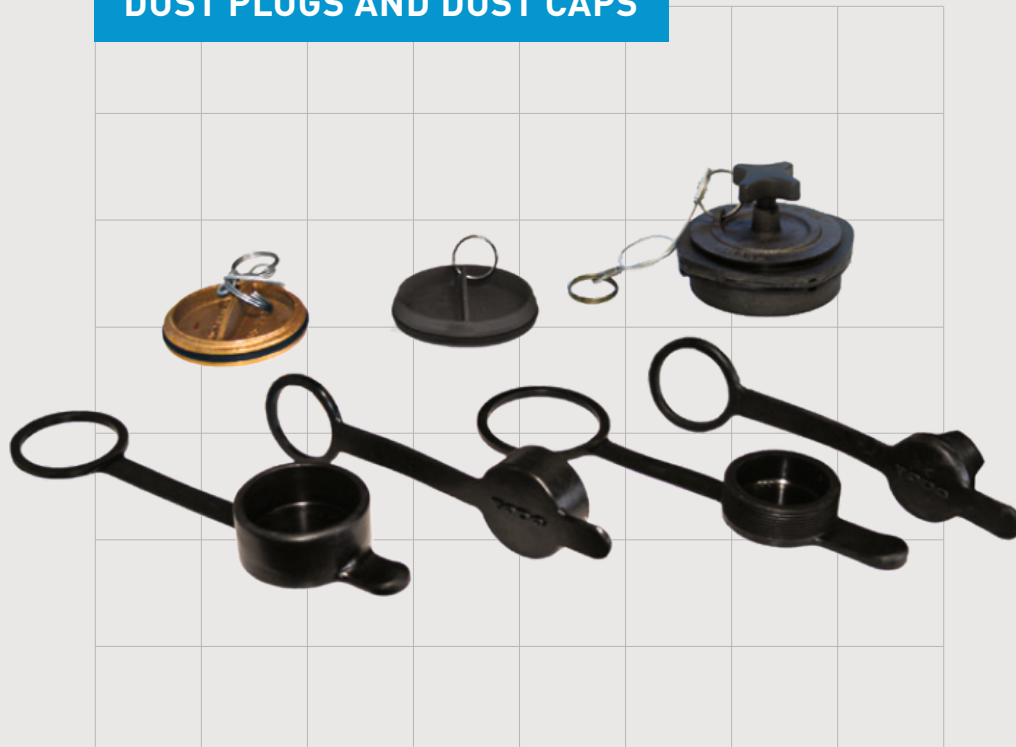
**DUST PLUGS AND DUST CAPS**

- Prevent ingress of dirt or water
- Materials:
  - 1" and 2" sizes: rubber
  - 3" size: stainless steel, brass/gunmetal and aluminium

**TODO**

**BLUEWATER RUBBER AND GASKET  
HOUMA**  
1131 Barrow St.  
Houma, LA 70360  
Phone: 985.851.2400  
Toll Free: 800.521.4673  
[www.BluewaterRubber.com](http://www.BluewaterRubber.com)



### PRESSURE RELIEF VALVE FOR TANK UNIT

- Highly recommended in applications where back-pressure build-up is common. Enables a small amount of pressure to be released in the hose unit to ease coupling motion



### PARKING DEVICE

- Provides a position for safe storage of hose units when not in use



### LONG DOUBLE HANDLE 2"

- Enables easier coupling motion, especially in applications where space is restricted at the connection point

# TODO



#### BLUEWATER RUBBER AND GASKET HOUMA

1131 Barrow St.  
Houma, LA 70360  
Phone: 985.851.2400  
Toll Free: 800.521.4673  
[www.BluewaterRubber.com](http://www.BluewaterRubber.com)

# 03

## NGX SERIES

### REDUCED SPILLAGE WHEN LOADING OR UNLOADING HAZARDOUS LIQUIDS

The NGX series focuses on preventing damage to the loading system while ensuring minimal product loss. The range combines flow optimisation with the latest innovations to bring you an industry-leading range of Safety Break-Aways. In the event of a drive/pull away incident, break pins are subjected to breaking force and eventually shear, causing the two halves of the Break-Away to separate. The two halves then rapidly close off, preventing liquid/gas from escaping the broken line.

# TODO



#### **BLUEWATER RUBBER AND GASKET HOUMA**

1131 Barrow St.  
Houma, LA 70360  
Phone: 985.851.2400  
Toll Free: 800.521.4673  
[www.BluewaterRubber.com](http://www.BluewaterRubber.com)



**2", 3", 4" TODO® BREAK-AWAY**DN50  
DN80  
DN100  
→HOW  
IT  
WORKS

- Extremely quick closing time
- Minimum loss of product
- Suitable for a wide range of applications

**TODO****BLUEWATER***Est.**1979***RUBBER & GASKET CO.****BLUEWATER RUBBER AND GASKET  
HOUMA**

1131 Barrow St.  
Houma, LA 70360  
Phone: 985.851.2400  
Toll Free: 800.521.4673  
[www.BluewaterRubber.com](http://www.BluewaterRubber.com)

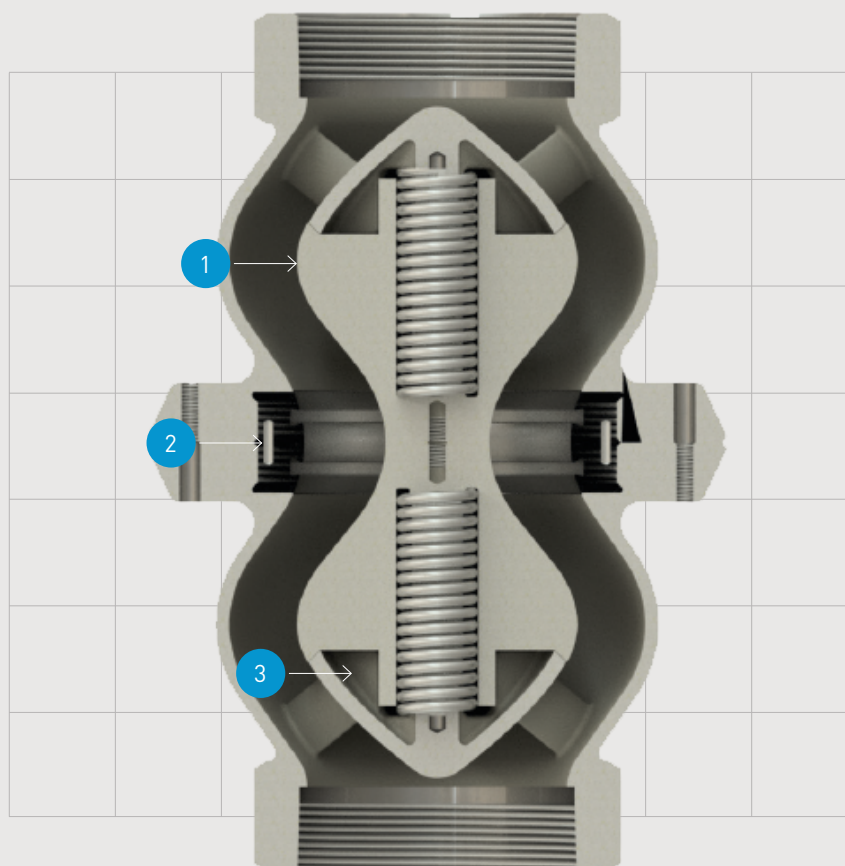
**TODO**DN50  
DN80  
DN100  
→HOW  
IT  
WORKS

1

Fluid Dynamic  
software optimised  
design for improved  
flow

2

Reconfigured seal  
location to reduce  
maintenance  
downtime

3

Shielded spring  
design – zero  
flow interruption

- Faster loading/unloading due to optimised flow rates
- Simple to retrofit onto loading arms
- Easier to handle when loading/unloading
- Reduced maintenance due to internal redesign and new seal placement
- Easy to reset on-site, saving time and money

**BLUEWATER RUBBER AND GASKET  
HOUMA**

1131 Barrow St.  
Houma, LA 70360  
Phone: 985.851.2400  
Toll Free: 800.521.4673  
[www.BluewaterRubber.com](http://www.BluewaterRubber.com)

# 04

## MARINE BREAK-AWAY

### ELIMINATING SPILLAGE DUE TO SHIP AND/OR BARGE MOVEMENT

The TODO® Marine Break-Away Coupling has been designed for loading and unloading hazardous liquids on ships and/or barges. The Marine version of TODO®'s tried and tested Standard Break-Away Coupling has a more robust design and has been engineered to withstand harsh marine conditions. If excessive load is detected, the coupler closes the valves and then allows disconnection.

# TODO



**BLUEWATER RUBBER AND GASKET  
HOUMA**  
1131 Barrow St.  
Houma, LA 70360  
Phone: 985.851.2400  
Toll Free: 800.521.4673  
[www.BluewaterRubber.com](http://www.BluewaterRubber.com)

## 4" MARINE BREAK-AWAY

DN100  
→HOW  
IT  
WORKS

- High flow/low pressure drop
- Designed to resist axial force so that disconnect only occurs when subjected to straight pull forces
- Operates independently of shut-off safety systems and does not require an external power source
- Easy to re-set on site

**TODO****BLUEWATER RUBBER AND GASKET  
HOUMA**

1131 Barrow St.  
Houma, LA 70360  
Phone: 985.851.2400  
Toll Free: 800.521.4673  
[www.BluewaterRubber.com](http://www.BluewaterRubber.com)

# 05

## TODO® SAFETY PRESSURE TIGHTCAP (PTC)

### DESIGNED WITH BUSINESS NEEDS IN MIND

Created in close collaboration with leading gas and oil companies, the TODO® Safety Pressure Tight Cap is designed to assure containment security and operational safety. It is equipped with sensors and failsafes to ensure operator safety and help avoid losses. No other existing closure technology comes close.

# TODO

## BLUEWATER



*Est.*

*1979*

RUBBER & GASKET CO.

### BLUEWATER RUBBER AND GASKET HOUMA

1131 Barrow St.  
Houma, LA 70360  
Phone: 985.851.2400  
Toll Free: 800.521.4673  
[www.BluewaterRubber.com](http://www.BluewaterRubber.com)

2" (DN 50) PTC | 3" (DN 80) PTC | 4" (DN 100) PTC

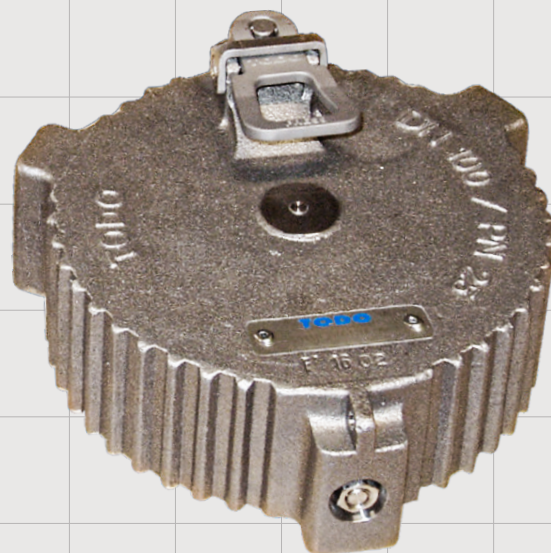
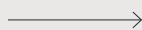
DN50  
DN80  
DN100

- Pressure indicator alerts the operator to pressure above 1.0 bar behind the cap and possible failure of upstream closure
- Allows for automatic depressurisation
- Reduces static pressure upstream of the cap
- Customs / tamper seal feature
- Suitable for use with all commonly used wire and plastic custom seals

**TODO**

**BLUEWATER RUBBER AND GASKET  
HOUMA**  
1131 Barrow St.  
Houma, LA 70360  
Phone: 985.851.2400  
Toll Free: 800.521.4673  
[www.BluewaterRubber.com](http://www.BluewaterRubber.com)

# 06

## AVIATION COUPLINGS

### THE ECONOMICAL ALTERNATIVE FOR AVIATION FUELLING

TODO® Aviation couplings represent real money savings as well as improved safety features and exceptional ease of use to organisations involved in the aviation industry. Their unrivalled reliability and robust design mean lower maintenance and replacement costs. Simple operation reduces human error and improves turnover time. The range includes the TODO®-45 coupling – the first economic alternative to the ISO 45 under wing hose couplers – and the TODO-MATIC® aviation hydrant connection.

# TODO



#### **BLUEWATER RUBBER AND GASKET HOUMA**

1131 Barrow St.  
Houma, LA 70360  
Phone: 985.851.2400  
Toll Free: 800.521.4673  
[www.BluewaterRubber.com](http://www.BluewaterRubber.com)

TODO®-45

DN65  
→

- Automatic valve opening on connection and disconnection
- Simple single action operation, no levers or switches
- Guaranteed valve closure prior to disconnection
- Minimal residual loss on disconnection
- Will connect and disconnect under pressure and flow where necessary
- Robust construction: no external operational components

**TODO****BLUEWATER***Est.**1979***RUBBER & GASKET CO.****BLUEWATER RUBBER AND GASKET  
HOUMA**

1131 Barrow St.  
Houma, LA 70360  
Phone: 985.851.2400  
Toll Free: 800.521.4673  
[www.BluewaterRubber.com](http://www.BluewaterRubber.com)



# 07

## TODO® FUEL NOZZLES

### DURABLE DESIGN FOR LONG-TERM PERFORMANCE

TODO® fuel nozzles are specifically designed to withstand the pressure of high volume delivery from tanker to the loading station in complete safety. High flow support means faster turnaround times, increasing your profit margins. Operator safety is always key, therefore with less product lost on disconnection and through human error, TODO® fuel nozzles ensure our customers are in safe hands.

# TODO



**BLUEWATER RUBBER AND GASKET  
HOUMA**  
1131 Barrow St.  
Houma, LA 70360  
Phone: 985.851.2400  
Toll Free: 800.521.4673  
[www.BluewaterRubber.com](http://www.BluewaterRubber.com)

## FUEL NOZZLES

1½"  
DN 40  
→



## ACCESSORIES RANGE:

- ✓ TODO-SNAP lug nut
- ✓ TODO-SNAP lug nut with 45° bend
- ✓ Sight glass
- ✓ Dust plug
- ✓ Hook spanner
- ✓ Outlet with extra-long swivelling lug nut
- ✓ Spout
- ✓ Lug nut tool

- Available with or without anti-drain valves
- Automatic handle locking when in closed position
- Optional threaded sight glass
- Ballsealings in PTFE (Teflon®) as standard
- TODO-SNAP log nut equipped on request
- Aluminium alloy components
- Working pressure: PN 10
- Safety factor: 1:5

# TODO

**BLUEWATER**



*Est.* 1979  
**RUBBER & GASKET CO.**

**BLUEWATER RUBBER AND GASKET  
HOUMA**  
1131 Barrow St.  
Houma, LA 70360  
Phone: 985.851.2400  
Toll Free: 800.521.4673  
[www.BluewaterRubber.com](http://www.BluewaterRubber.com)

# 08

## BALL VALVES

### IMPROVED PERFORMANCE, LARGER SAVINGS

TOD0®'s lightweight ball valves offer real cash savings to the road and tanker industry. Designed to work specifically in any context which involves regular compartment switching, the ball valves are also used in fixed plant and mobile refuelling applications. The unrivalled sandwich design ensures that quick, easy valve changeover is permitted with a PTFE seal preventing leakage – all of which helps to save businesses time and money.

# TOD0



**BLUEWATER RUBBER AND GASKET  
HOUMA**  
1131 Barrow St.  
Houma, LA 70360  
Phone: 985.851.2400  
Toll Free: 800.521.4673  
[www.BluewaterRubber.com](http://www.BluewaterRubber.com)

## ONE WAY BALL VALVES

2" DN50  
3" DN80  
4" DN100  
→



## FEATURES

- ✓ Aluminium valve body and ball
- ✓ Easy to service
- ✓ PTFE ball sealing
- ✓ Operates under pressure and flow
- ✓ Extremely reliable
- ✓ Robust construction
- ✓ Available with handle or actuator
- ✓ Working Pressure: PN 10
- ✓ Safety factor: 5:1

# TODO



Ideal for use in road tankers and a variety of plant applications to permit flow in one direction only, TODO® one way ball valves are available with pneumatic actuation and with a wide selection of end connectors.

Available products:

- 4" ball valve with actuator
- 3" ball valve
- 2" ball valve

## BLUEWATER RUBBER AND GASKET HOUMA

1131 Barrow St.  
Houma, LA 70360  
Phone: 985.851.2400  
Toll Free: 800.521.4673  
[www.BluewaterRubber.com](http://www.BluewaterRubber.com)

**TWO WAY BALL VALVES**

2" DN50  
3" DN80  
4" DN100  
→

**FEATURES**

- ✓ Aluminium valve body and ball
- ✓ Easy to service
- ✓ PTFE ball sealing
- ✓ Operates under pressure and flow
- ✓ Extremely reliable
- ✓ Robust construction
- ✓ Available with handle or actuator
- ✓ Working Pressure: PN 10
- ✓ Safety factor: 5:1

**TODO**

Offering all the benefits of one way ball valves, the two way ball valves range is ideal for use as a compartment or tank switching valve, to control the direction of flow between either of two outlets.

Available products:

- 4" ball valve with actuator
- 3" ball valve
- 2" ball valve

**BLUEWATER RUBBER AND GASKET  
HOUMA**

1131 Barrow St.  
Houma, LA 70360  
Phone: 985.851.2400  
Toll Free: 800.521.4673  
[www.BluewaterRubber.com](http://www.BluewaterRubber.com)

# 09

## TODO® SWIVEL

### IMPROVING MANOEUVRABILITY TO AVOID HOSE FAILURE

One of the biggest causes of premature hose failure – and therefore maintenance costs and wasted time – is torque stress imparted onto the assembly hose by permitting free hose movement. The leading technology in the TODO® Swivel avoids this stress, allowing the hose to relax to its natural rest position, whilst permitting its free movement.

# TODO



**BLUEWATER RUBBER AND GASKET  
HOUMA**

1131 Barrow St.  
Houma, LA 70360  
Phone: 985.851.2400  
Toll Free: 800.521.4673  
[www.BluewaterRubber.com](http://www.BluewaterRubber.com)

## TODO® SWIVEL RANGE

0.75" - 4"



## FEATURES

- ✓ 4" BSP female - male
- ✓ 3" flange - BSP - male
- ✓ 2½" BSP female - male
- ✓ 2" BSP male - NPT female
- ✓ 1½" BSP male - female
- ✓ 1½" BSP male - male
- ✓ 1" BSP male - female

- Simple design
- Low maintenance
- High reliability
- Very compact
- High flow rate / low pressure drop
- Stainless steel bearings and single o-ring seal

**TODO**

**BLUEWATER RUBBER AND GASKET  
HOUMA**  
1131 Barrow St.  
Houma, LA 70360  
Phone: 985.851.2400  
Toll Free: 800.521.4673  
[www.BluewaterRubber.com](http://www.BluewaterRubber.com)

# CERTIFICATES AND STANDARDS

Designed for demanding applications, TODO-MATIC® couplings carry the highest level of certifications and approvals available worldwide:

- VdTÜV under test approval mark TÜ.AGG.162-93 towards ADR, RID and IMDG
- European directives
- 2014/68/EU (PED) and 2014/34/EU (ATEX) compliance
- E4 Automotive liquefied petroleum gas components – other than containers.

Additionally, all TODO® products meet the highest international for safety and have the following attestations:

- TDT approval
- mark TDT-UW-30/09 (swivels) and TDT-UQ-30/09 (fuel nozzles)
- ADR/RID in Poland
- EN ISO 9001:2000 (ball valves) and EN ISO 9001:2015 (swivels and fuel nozzles) manufacturing standards
- ISO 14001:2015



**“WHEN I LOOK TO BUY A DRY-BREAK®  
VALVE FOR MY PROJECT  
– I ASK FOR A TODO®”**

# TODO

## BLUEWATER



**BLUEWATER RUBBER AND GASKET  
HOUMA**

1131 Barrow St.  
Houma, LA 70360  
Phone: 985.851.2400  
Toll Free: 800.521.4673  
[www.BluewaterRubber.com](http://www.BluewaterRubber.com)



**BLUEWATER RUBBER AND GASKET  
BELLE CHASSE**

1802-A Engineers Rd.  
Belle Chasse, LA 70037  
Phone: 504.392.3001  
Toll Free: 866.392.3001  
www.BluewaterRubber.com

**BLUEWATER RUBBER AND GASKET  
GALLIANO**

17650 Hwy. 3235  
Galliano, LA 70354  
Phone: 985.632.4200  
Toll Free: 800.521.4673  
www.BluewaterRubber.com

**BLUEWATER RUBBER AND GASKET  
BATON ROUGE**

6629 Pecue Lane  
Baton Rouge, LA 70817  
Phone: 225.570.4900  
Toll Free: 800.521.4673  
www.BluewaterRubber.com

# TODO

## MANUFACTURING FACILITIES

### TODO

Channel Road,  
Westwood Industrial Estate,  
Margate,  
Kent,  
CT9 4JR UK  
Phone +44 (0)1843 221521  
Fax +44 (0)1843 295444

### SALES OFFICE

#### Emco Wheaton

Channel Road,  
Westwood Industrial Estate,  
Margate,  
Kent,  
CT9 4JR UK  
Phone +44 (0)1843 221521  
Fax +44 (0)1843 295444

#### Emco Wheaton GmbH

Emcostraße 2-4,  
35274,  
Kirchhain,  
Germany  
Phone +49 6422 84-0  
Fax +49 6422 5100

#### Emco Wheaton USA, Inc.

9111 Jackrabbit Road,  
Houston,  
Texas,  
77095  
USA  
Phone +1 281 856-1300  
Fax +1 281 856-1325

#### Emco Wheaton France S.A.S.

Division Produits Industriels 70,  
Avenue Albert Einstein,  
Zone du Château d'Eau  
B.P. 50061 - F77551  
Moissy-Cramayel Cedex,  
France,  
Phone +33 1 64 13 89 49  
Fax +33 1 64 13 37 08

#### Emco Wheaton GmbH

Hofherr-Schranz-Gasse 4,  
1210 Wien - Österreich,  
Austria  
Phone +43 1 270 11 99 - 35  
Fax +43 1 270 11 99 - 11

#### Emco Wheaton GmbH

Presnenskaya emb. 10  
Block C – Embankment Tower – of. 526  
123317 Moscow  
Russia  
Phone +7 495 9677612  
Fax +7 495 9677600

#### Emco Wheaton Asia Pacific

21-5F IOI Business Park,  
Bandar Puchong Jaya,  
Puchong, 47170,  
Selangor, Malaysia  
Phone +603 8075 7500  
Fax +603 8075 4100

#### Gardner Denver International Ltd

PO Box 30804  
Diraz, Manama  
Bahrain  
Phone +973 17813187  
Fax +973 17813186

#### Emco Wheaton

Av. Mercedes Benz,  
700 - Distrito Industrial-  
Campinas 13054-750,  
SP Brazil  
Phone +55 19 3765 8303  
Mobile +55 19 98168 8516

#### Gardner Denver Belgium N.V.

Luithagen 7A – Haven 200  
B-2030 Antwerpen,  
Belgium,  
Phone +32 (0)3 541 50 40

#### Gardner Denver Nederland B.V.

Barwoutswaarder 3  
3449HE Woerden  
Postbus 299  
3440AG  
Woerden  
Phone +31 (0)348 410150

#### Gardner Denver Machinery (Shanghai) Co., Ltd.

No. 200 Xin Tuan Rd  
Qingpu Industrial Zone  
Shanghai  
P.R. China  
Phone +86 (0) 21 3127 6266  
Fax +86 (0) 21 31276206

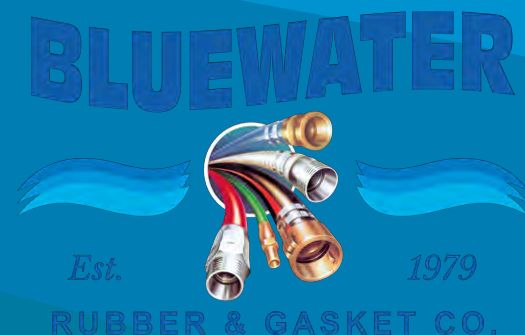

[www.emcowheaton.com/todo-products](http://www.emcowheaton.com/todo-products)

 [www.linkedin.com/company/TODOcouplers](https://www.linkedin.com/company/TODOcouplers)